

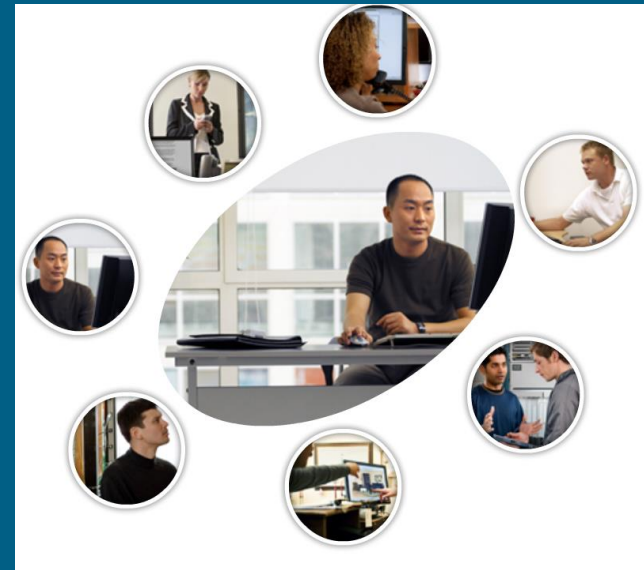

Router Initialization steps



Router Initialization Steps.

1. POST
2. loading Bootstrap program from ROM into RAM.
3. Loading IOS image into RAM.
4. Loading Configuration file into RAM.
 - After POST is done the bootstrap program is loaded from ROM Into RAM to be executed
 - The main job of bootstrap program is HOW to get the IOS loaded into RAM.

Router CPU and Memory

- **CPU**
 - Executes operating system instructions
- **RAM**
 - running copy of configuration file.
 - routing table
 - ARP cache
- **Read-only memory (ROM)**
 - POST used when router is powered up.
 - Router's bootstrap program
 - Scaled down version of operating system IOS
- **Non-volatile RAM (NVRAM)**
 - Stores startup configuration. (including IP addresses, Routing protocol)
- **Flash memory** - Contains the operating system (Cisco IOS)

Router Bootup Process

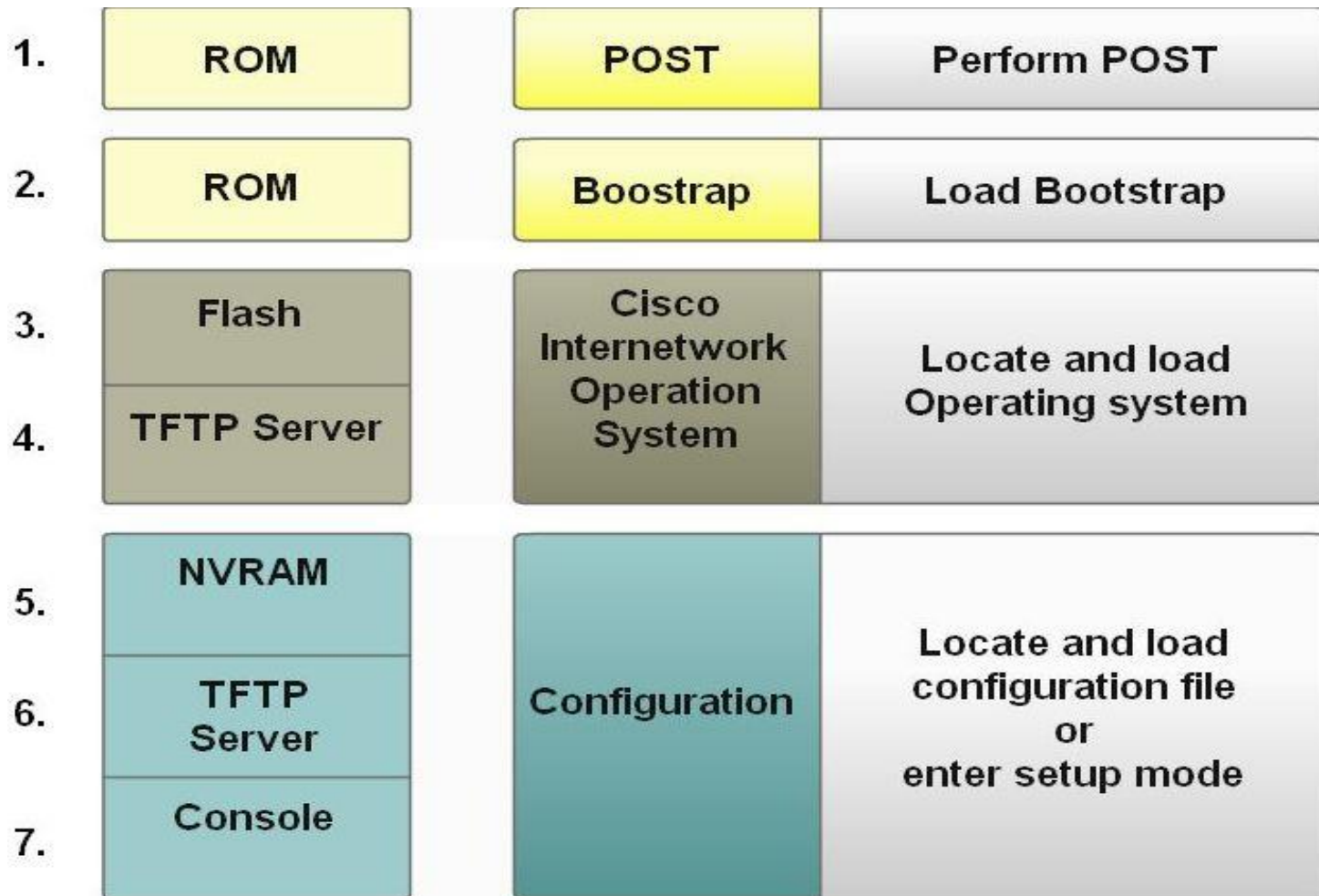

Bootup Process

Step 1: POST (Power On Self Test)

- Executes diagnostics from ROM on several hardware components, including the CPU, RAM, NVRAM

Step 2: Loading Bootstrap Program

- Copied from ROM into RAM
- Executed by CPU
- Main task is to locate the Cisco IOS and load it into RAM

Step 3: Locating the IOS

- Typically stored in flash memory, but it can be stored in other places such as a TFTP server.
- If a full IOS image cannot be located, a scaled-down version of the IOS is copied from ROM
- This version of IOS is used to help diagnose any problems and to try to load a complete version of the IOS into RAM.

Boot up Process

Step 4: Loading the IOS

- Some of the older Cisco routers ran the IOS directly from flash
- Current models copy the IOS into RAM for execution
- Might see a string of pound signs (#) while the image decompresses.

Step 5: Locating the Config File

- Bootstrap program searches for the startup configuration file (startup-config), in NVRAM.
- This file has the previously saved configuration commands and parameters,

Step 6: Loading the Config File

- If a startup configuration file is found in NVRAM, the IOS loads it into RAM as the running-config file and executes the commands.
- If the startup configuration file cannot be located, prompt the user to enter **setup mode**

Step in Router Initialization

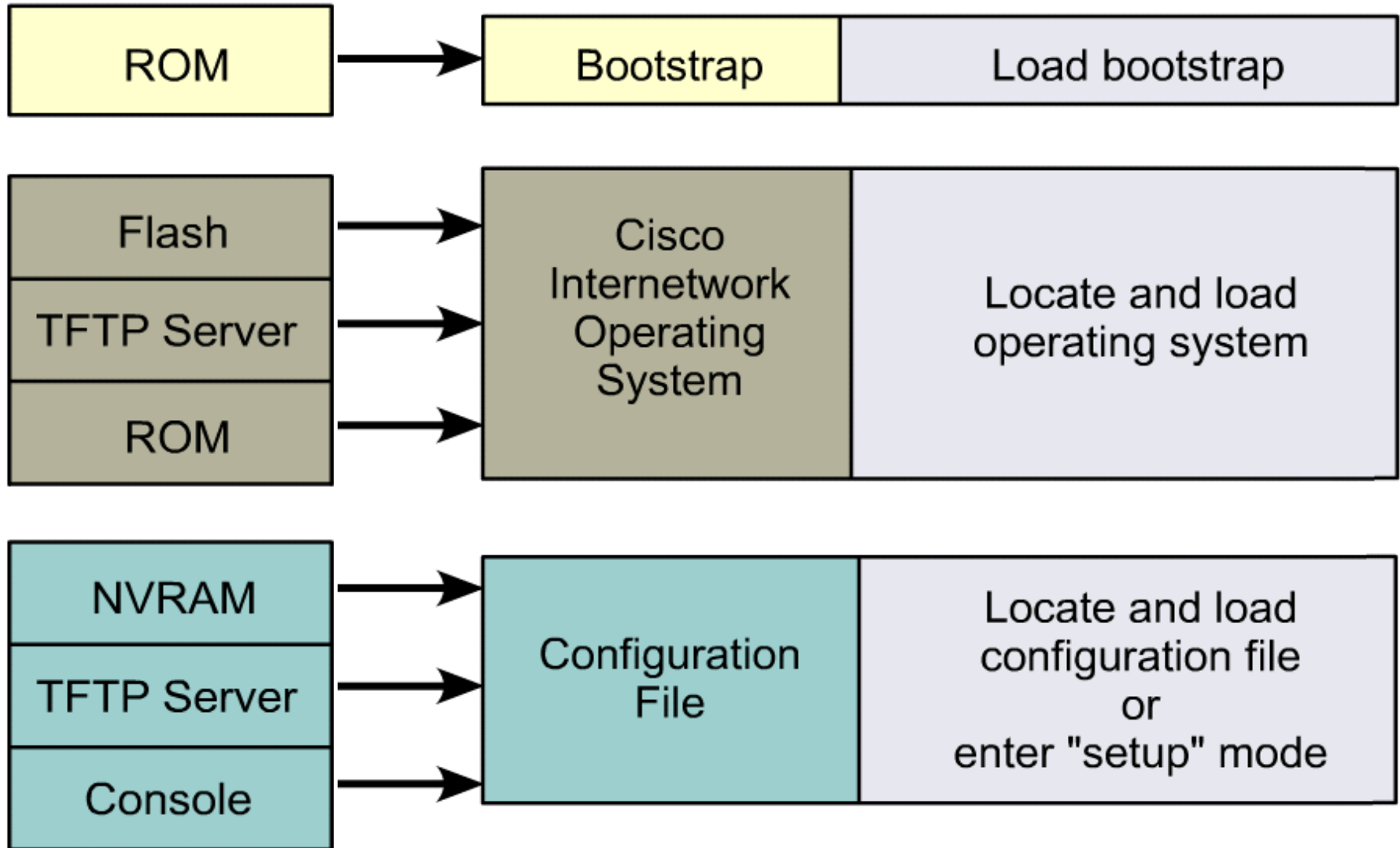

ROM Functions

ROM

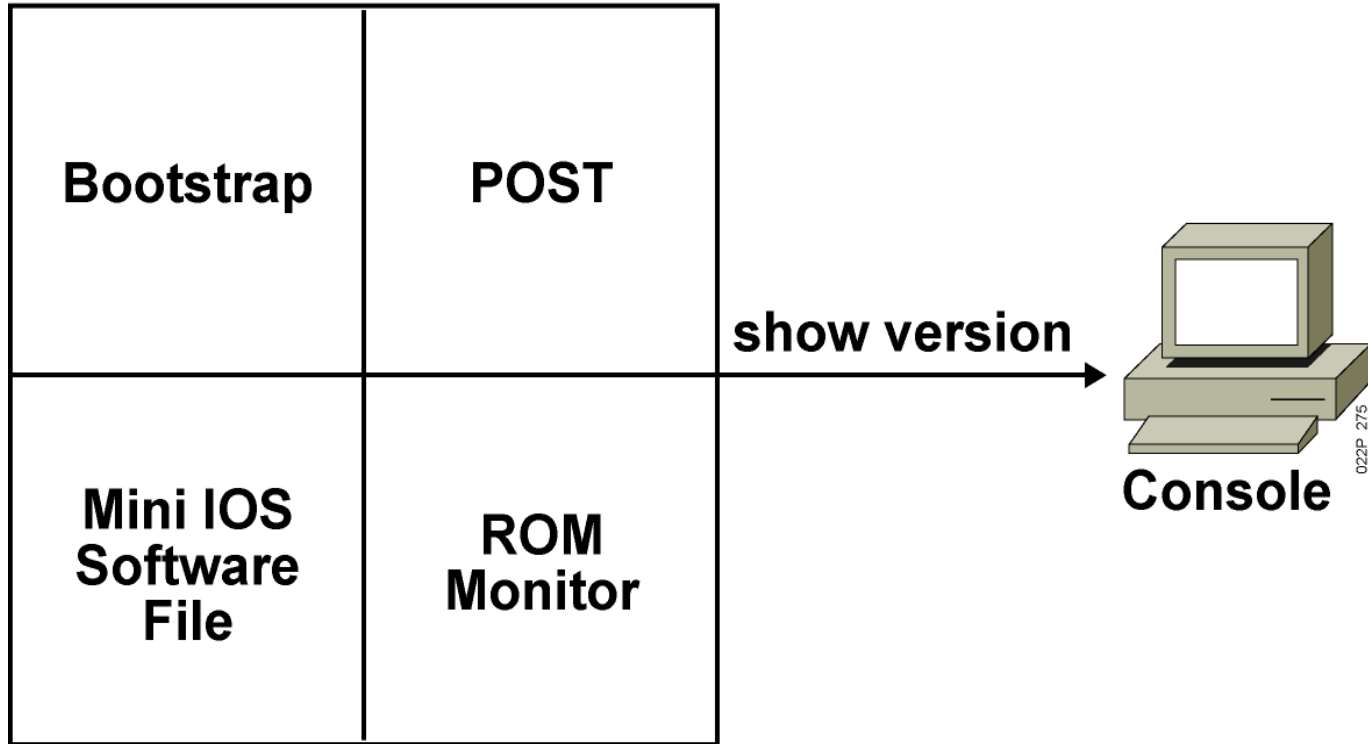

- **Contains microcode for basic functions**

Loading the Cisco IOS Image from Flash Memory

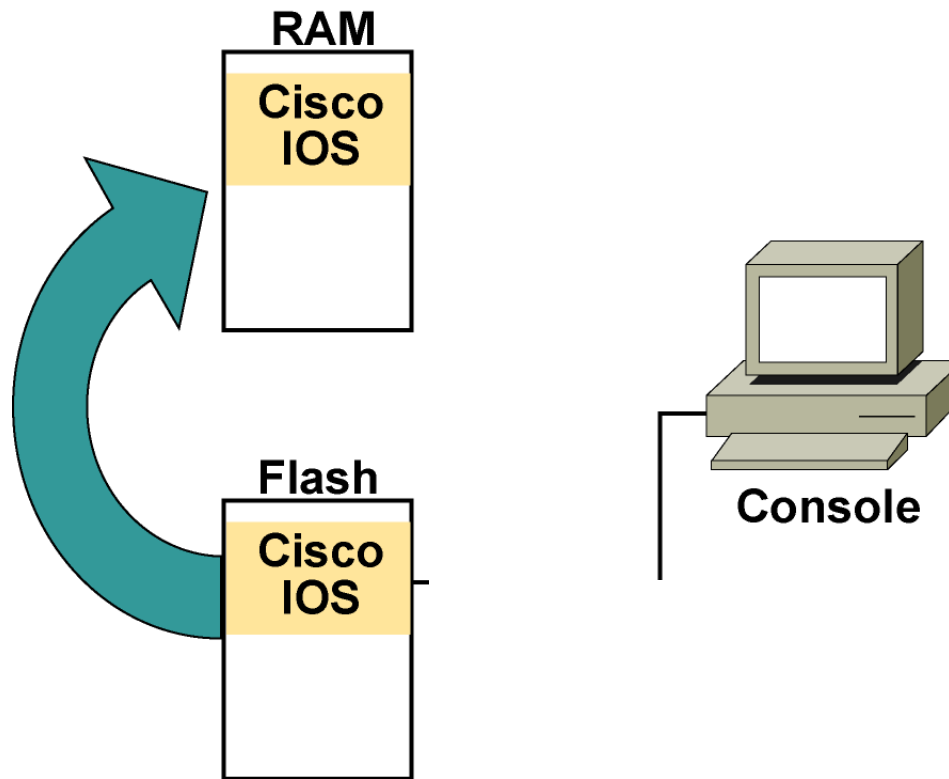

- **The flash memory file is decompressed into RAM.**

Loading the Configuration

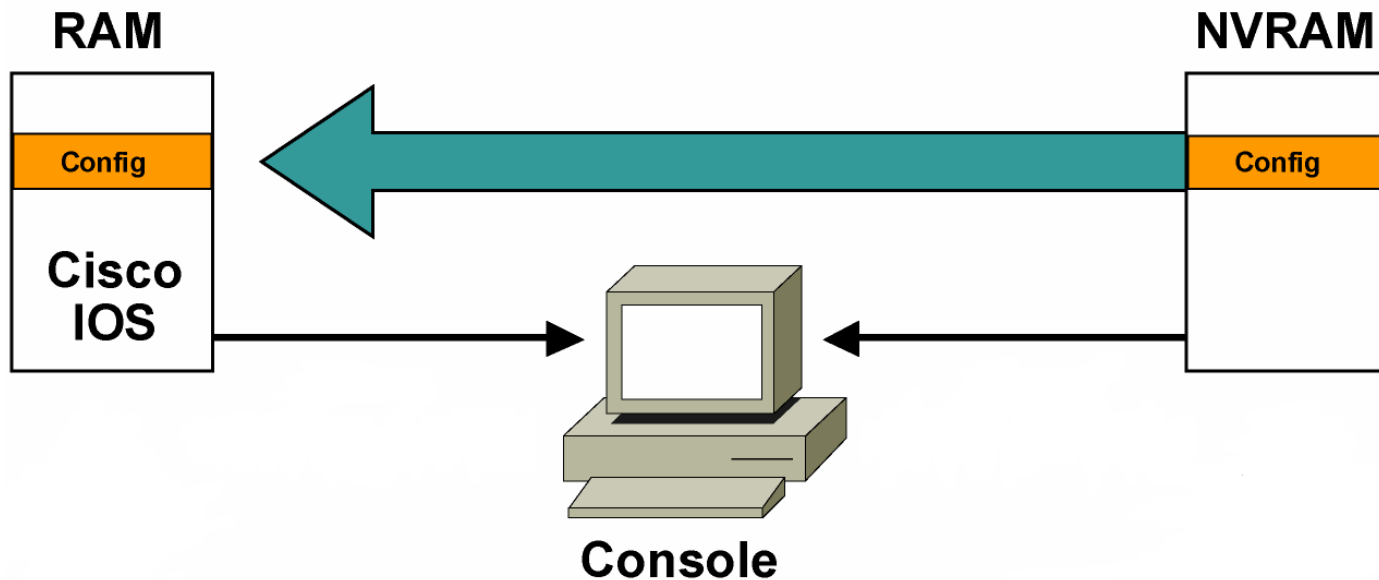

- **Load and execute the configuration from NVRAM.**

SECTION SUMMARY

- 1. Router hardware components**
- 2. Cisco Software components**
- 3. Router memory**
- 4. Router Initialization Steps.**



Router Access

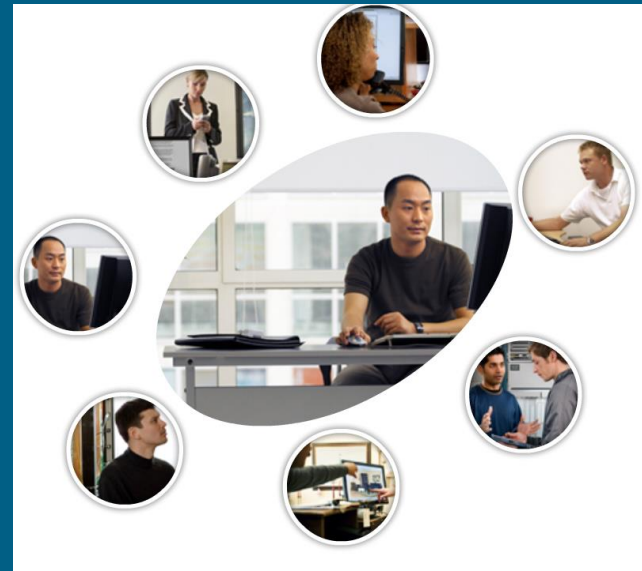

ROUTER ACCESS METHODS

- Directly using the console port
 - No configuration needed on the router
- Telnet – over the network
 - Network connection
 - Network configuration on both ends (IP address, subnet mask, etc.)
 - Telnet password configured on router
- Modem (AUX.PORT on the router)
- Web access

Console

- The console port is a management port that provides out-of-band access to a router.
- Examples of console use are:
 - The initial configuration of the network device
 - Disaster recovery procedures and troubleshooting where remote access is not possible
 - Password recovery procedures

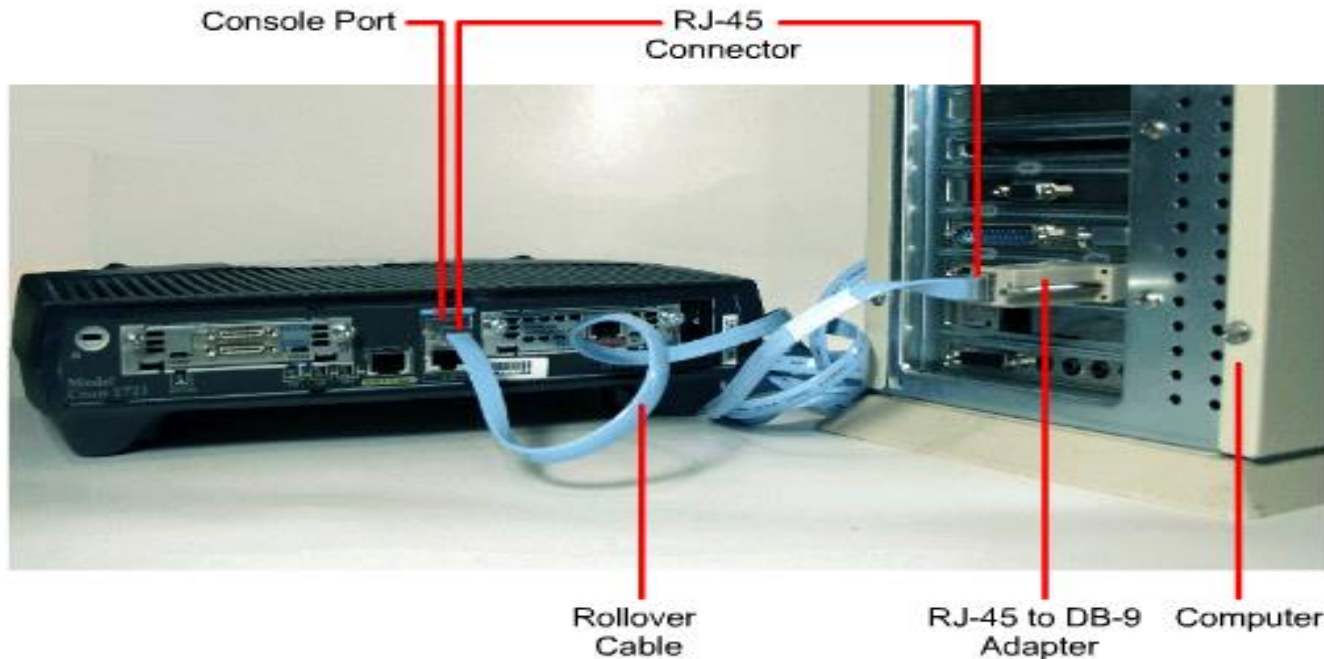

AUXILIARY

Auxiliary Port

RJ-45
Connector

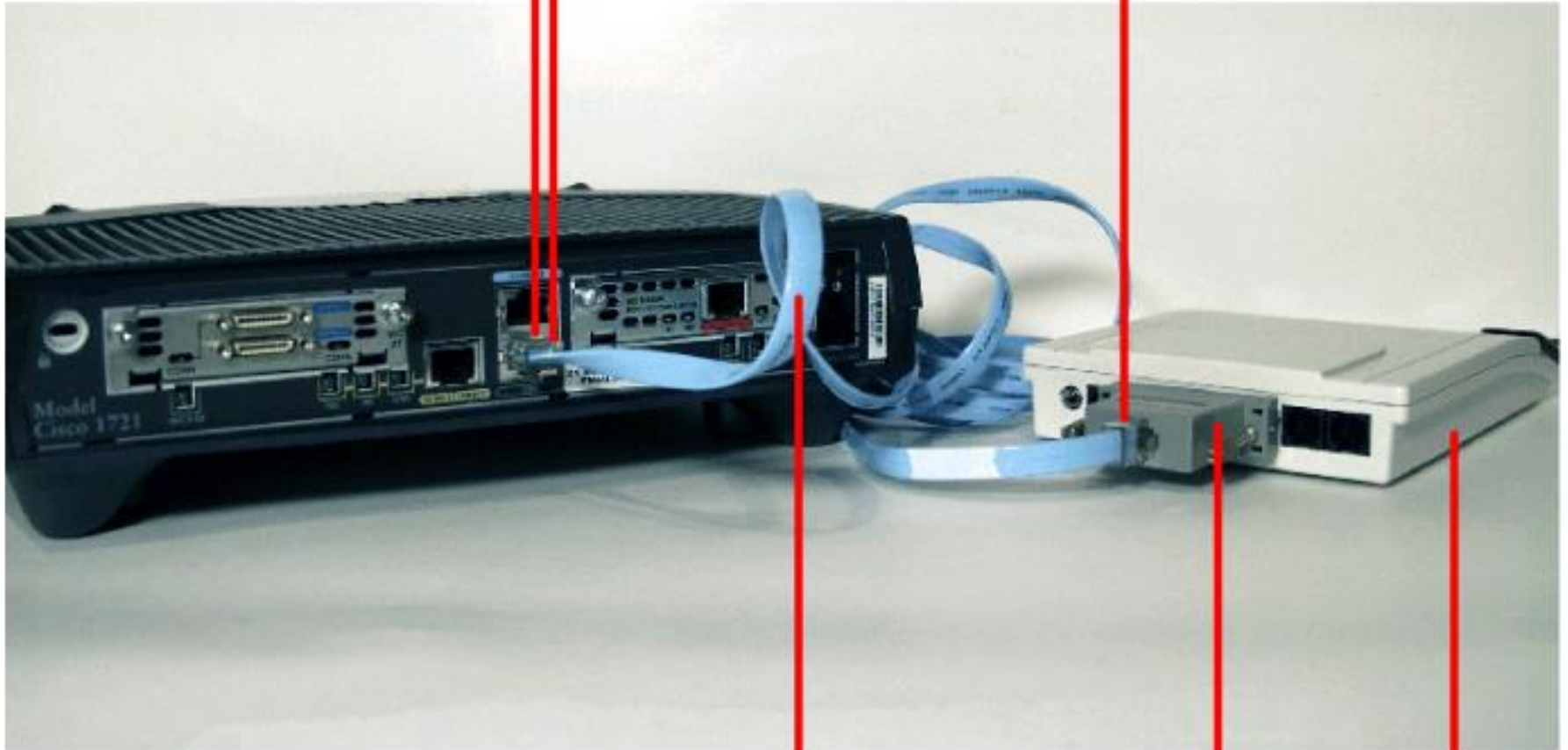

Router

RJ-45 to DB-25

Modem

Using HyperTerminal

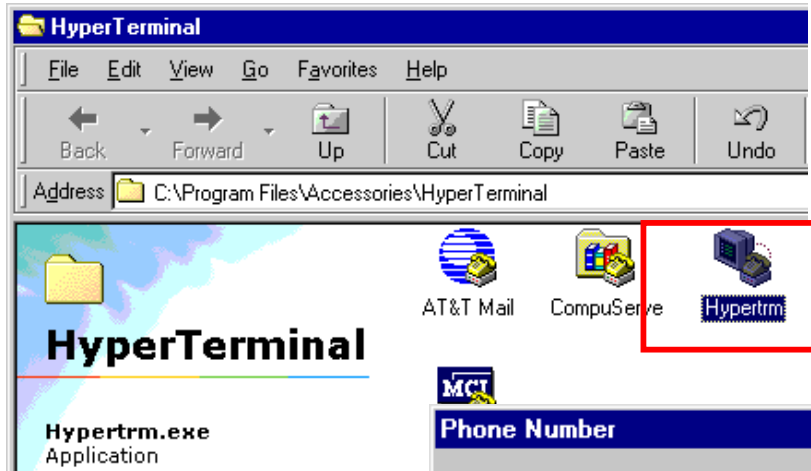

Settings

Match serial port on PC

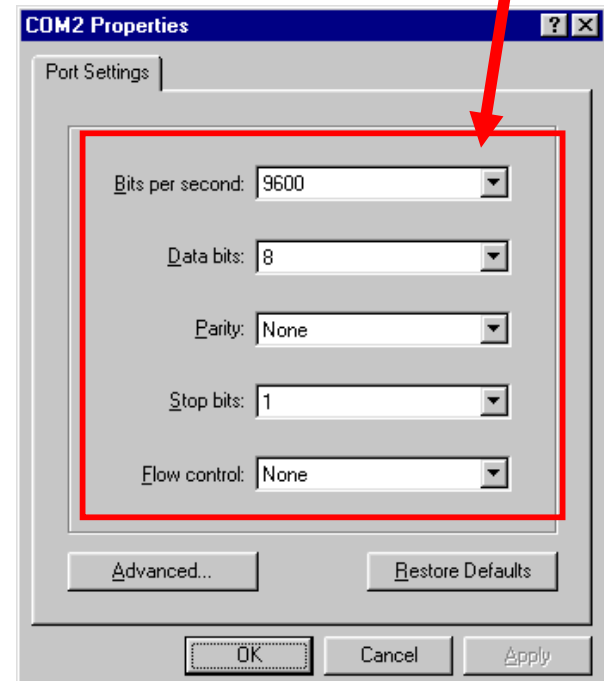
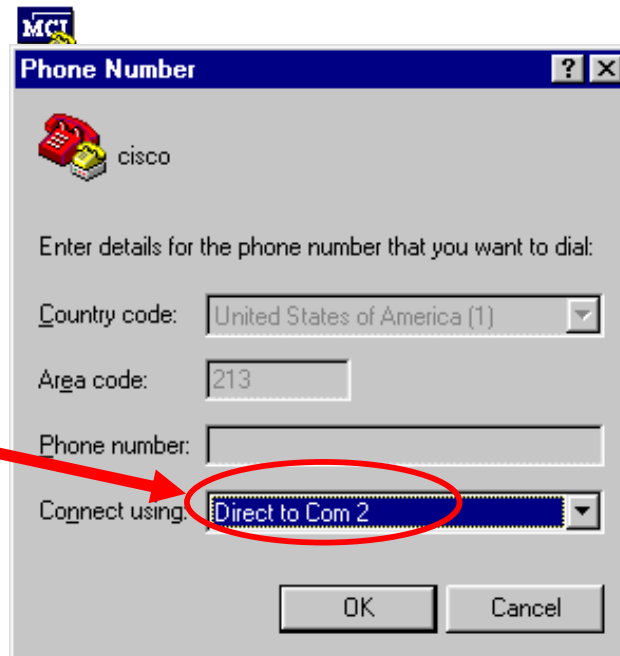

AUX

- Another way to establish a CLI session remotely is via a telephone dialup connection using a modem connected to the router's AUX port.
- Similar to the console connection, this method does not require any networking services
- The AUX port can also be used locally, like the console port.
- Generally, the only time the AUX port is used locally instead of the console port is when there are problems using the console port

Telnet and SSH

- Unlike the console connection, Telnet sessions require active networking services on the device.
- A host with a Telnet client can access the z sessions running on the Cisco device.
- The Secure Shell (SSH) protocol is a more secure method for remote device access.
- SSH client software is not provided by default on all computer operating systems.

Setup mode

- Permit the administrator to install a minimal configuration for a router (appeared if no saved configuration , Ctrl-C to skip)

```
--- System Configuration Dialog ---

Would you like to enter the initial configuration dialog? [yes/no]:
Y

At any point you may enter a question mark '?' for help.
Use ctrl-c to abort configuration dialog at any prompt.
Default settings are in square brackets '[]'.

Basic management setup configures only enough connectivity
for management of the system, extended setup will ask you
to configure each interface on the system
Would you like to enter basic management setup? [yes/no]: no
First, would you like to see the current interface summary? [yes]:
no
Configuring global parameters:
..
..text omitted ..
..
[0] Go to the IOS command prompt without saving this config.
[1] Return back to the setup without saving this config.
[2] Save this configuration to nvram and exit.

Enter your selection [2]:
Building configuration...
[OK]
Use the enabled mode 'configure' command to modify this
configuration.
```

Setup Mode

- The router will enter setup mode when:
 - The contents of NVRAM have been erased with the “erase start” command
 - When the router is “out of the box” and has not been initially configured
 - After deleting the backup configuration and reloading the router
- You can make the router enter setup mode by entering:
 - Router#setup

SECTION SUMMARY

1. ROUTER ACCESS METHODS

- Console , AUXILIARY , TELNET , WEB ACCESS

2. Using HyperTerminal

3. Telnet and SSH

4. Setup mode



CLI First look



ROUTER Modes

◆ User Exec mode

Router>

◆ Privileged Exec mode

Router#

◆ Global configuration mode

Router (config) #

◆ Specific Configuration modes



end

exit

Configuration Mode	Prompt
Interface	Router (config-if) #
Subinterface	Router (config-subif) #
Controller	Router (config-controller) #
Map-list	Router (config-map-list) #
Map-class	Router (config-map-class) #
Line	Router (config-line) #
Router	Router (config-router) #
IPX-router	Router (config-ipx-router) #
Route-map	Router (config-route-map) #

User EXEC Mode

- The user EXEC mode allows only a limited number of basic monitoring commands.
- This is often referred to as a view only mode.
- The user EXEC level does not allow any commands that might change the configuration of the router.
- The user EXEC mode can be identified by the > prompt.

Privileged EXEC Mode

- The privileged EXEC mode provides access to all router commands.
- This mode can be configured to require a password.
- Configuration and management commands require that the network administrator be at the privileged EXEC level.
- Global configuration mode and all other more specific configuration modes can only be reached from the privileged EXEC mode.
- The privileged EXEC mode can be identified by the # prompt.

Moving between the User EXEC and Privileged EXEC Modes

IOS Modes

```
Router con0 is now available.  
Press RETURN to get started.  
  
User Access Verification  
Password:  
Router> ← User-Mode Prompt  
Router>enable  
Password:  
Router# ← Privileged-Mode  
Router#disable  
Router> ← User-Mode Prompt  
Router>exit
```

Router

Click to see output from different devices.

Router

Switch

Basic IOS command structure

- Identify the basic command structure for IOS commands

Basic IOS Command Structure

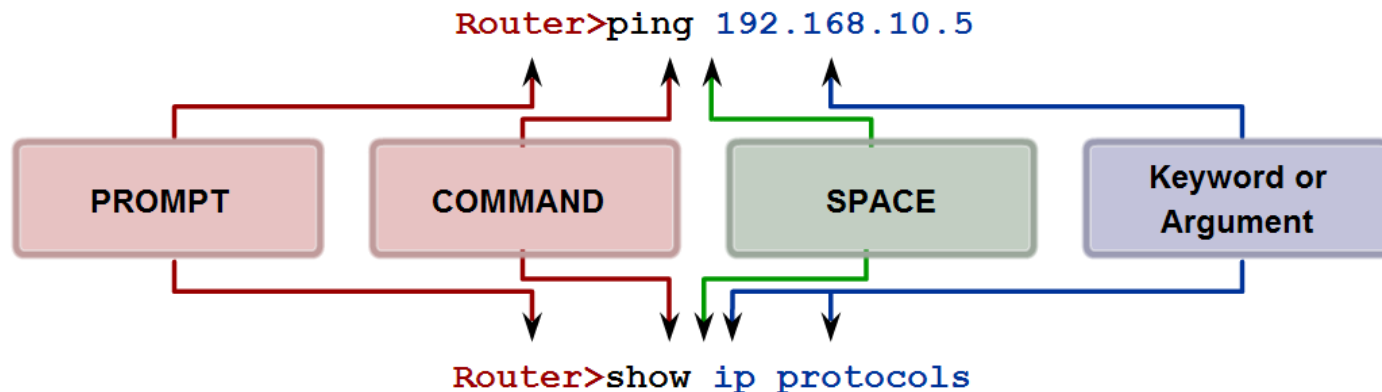

Prompt commands are followed by a space and then the keyword or arguments.

Using CLI help

- Identify the types of help and feedback available while using IOS and use these features to get help, take shortcuts and ascertain success

Using CLI help

Command Syntax Check Help

The IOS returns a help message indicating that required keywords or arguments were left off the end of the command:

```
Switch#>clock set
% Incomplete command.
Switch#clock set 19:50:00
% Incomplete command.
```

The IOS returns a help message to indicate that there were not enough characters entered for the command interpreter to recognize the command.

```
Switch#c
% Ambiguous command: 'c'
```

The IOS returns a "^" to indicate where the command interpreter can not decipher the command:

```
Switch#clock set 19:50:00 25 6
                        ^
% Invalid input detected at '^' marker.
```

Using CLI help

Error Message	Meaning	Examples	How to Get Help
<code>% Ambiguous command: 'command'</code>	not enough characters entered for the IOS to recognize the command	<code>Switch#c</code> <code>% Ambiguous command: 'c'</code>	Reenter the command followed by a question mark (?) with no space between the command and the question mark. The possible keywords that you can enter with the command are displayed.
<code>% Incomplete command.</code>	not all of the required keywords or arguments were entered	<code>Switch#clock set</code> <code>% Incomplete command.</code>	Reenter the command followed by a question mark (?) with a space after last word. The required keywords or arguments are displayed.
<code>% Invalid input detected at '^' marker</code>	command was entered incorrectly. The error occurred where the caret mark (^) appears.	<code>Switch#clock set</code> <code>19:50:00 25 6</code> <code> ^</code> <code>% Invalid input detected at '^' marker.</code>	Reenter the command followed by a question mark (?) in a place pointed by '^' mark. It can be also needed to delete last keyword(s) or argument(s).

Abbreviated commands (Router and Switch)

```
Router# sh inter
```

Same as

```
Router# show interfaces
```



IOS "examination" commands

- Identify the purpose of the show command and several of its variations

IOS show commands can provide information about the configuration, operation and status of parts of a Cisco router.

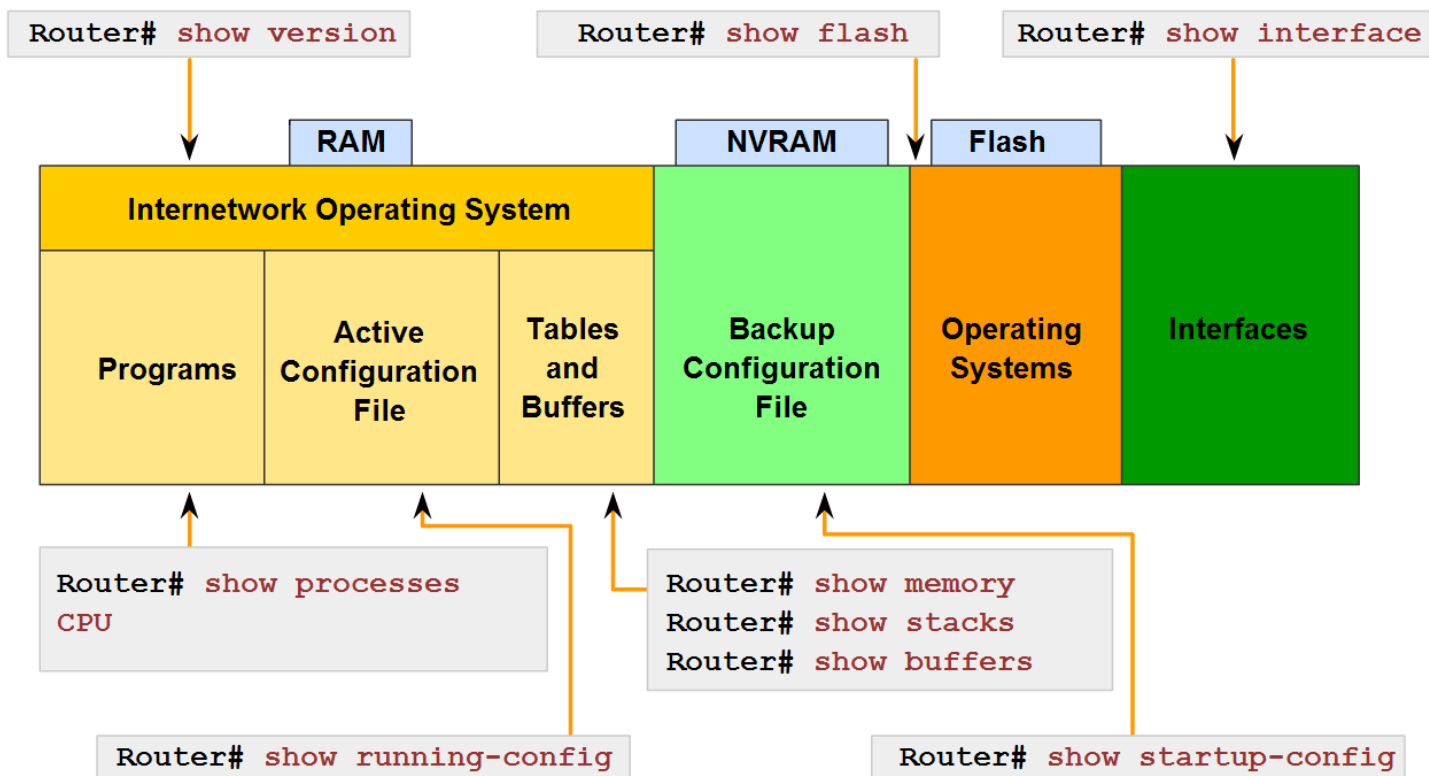

```
BHM#show flash
```

```
PCMCIA flash directory:
```

```
File Length Name/status
```

```
1 6007232 c1700-bnsy-1.212-11.p
```

```
[6007296 bytes used, 284160 available, 6291456
```

```
total]
```

```
6144K bytes of processor board PCMCIA flash (Read
```

```
ONLY)
```

```
BHM#
```

This command will show all of the Cisco IOS image files – not just the one that the router booted from.

Might compare to a directory listing

IOS software and features

- The naming convention for the different Cisco IOS releases contains three parts:
 - The platform on which the image runs
 - The special features supported in the image
 - Where the image runs and whether it has been zipped or compressed

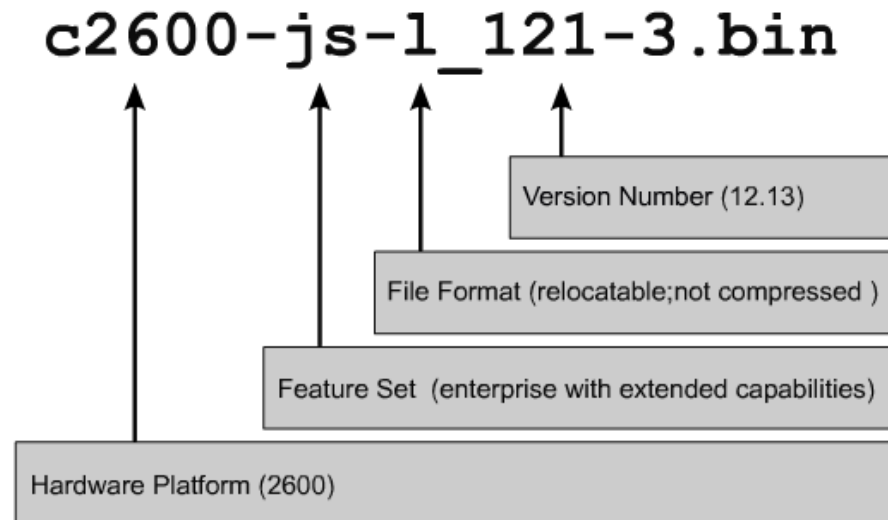

show version Command

```
wg_ro_a#show version
Cisco Internetwork Operating System Software
IOS (tm) C2600 Software (C2600-JS-M), Version 12.0(8), RELEASE SOFTWARE (fc1)
Copyright (c) 1986-1999 by cisco Systems, Inc.
Compiled Mon 29-Nov-99 15:26 by kpma
Image text-base: 0x80008088, data-base: 0x80B081E0

ROM: System Bootstrap, Version 11.3(2)XA4, RELEASE SOFTWARE (fc1)

wg_ro_a uptime is 3 weeks, 2 days, 17 hours, 24 minutes
System restarted by reload at 13:05:09 UTC Fri May 3 2002
System image file is "flash:c2600-js-mz.120-8.bin"

cisco 2610 (MPC860) processor (revision 0x300) with 53248K/12288K bytes of memory.
Processor board ID JAD06090BMD (2719249260)
M860 processor: part number 0, mask 49
Bridging software.
X.25 software, Version 3.0.0.
SuperLAT software (copyright 1990 by Meridian Technology Corp).
TN3270 Emulation software.
Basic Rate ISDN software, Version 1.1.
1 Ethernet/IEEE 802.3 interface(s)
2 Serial(sync/async) network interface(s)
1 ISDN Basic Rate interface(s)
32K bytes of non-volatile configuration memory.
16384K bytes of processor board System flash (Read/Write)

Configuration register is 0x2102 (will be 0x2142 at next reload)
```

Router up
time

Last restart
method

IOS version

System image file
& location

Number & type of
interfaces on the
router

Configuration
register setting

NVRAM SPACE
FLASH SPACE

022P_250

show version Command

Verify the router boot up process

How a Router Boots up

Router#show version
Cisco Internetwork Operating System Software
IOS version ← IOS (tm) C2600 Software (C2600-I-M), Version 12.2(28), RELEASE SOFTWARE (fc5)
Technical Support: <http://www.cisco.com/techsupport>
Copyright (c) 1986-2005 by cisco Systems, Inc.
Compiled Wed 27-Apr-04 19:01 by miwang
Image text-base: 0x8000808C, data-base: 0x80A1FECC

Bootstrap version ← ROM: System Bootstrap, Version 12.1(3r)T2, RELEASE SOFTWARE (fc1)
Copyright (c) 2000 by cisco Systems, Inc.
ROM: C2600 Software (C2600-I-M), Version 12.2(28), RELEASE SOFTWARE (fc5)
System returned to ROM by reload
System image file is "flash:c2600-i-mz.122-28.bin"

Model and CPU ← cisco 2621 (MPC860) processor (revision 0x200) with 60416K/5120K bytes of memory.
Amount of RAM ← Processor board ID JAD05190MTZ (4292891495)
M860 processor: part number 0, mask 49
Bridging software.
X.25 software, Version 3.0.0.

Number and type of interfaces ← 2 FastEthernet/IEEE 802.3 interface(s)
2 Low-speed serial(sync/async) network interface(s)

Amount of NVRAM ← 32K bytes of non-volatile configuration memory.

Amount of Flash ← 16384K bytes of processor board System flash (Read/Write)

Configuration register is 0x2102
Router#

IOS loading control

Router use the following logic to load an IOS

- Load minimized IOS from ROM based on the **config. Register setting** for 0x2101 or 0x2100
- Load the IOS based on the configuration of the **bootsystem command** in the start –up config. File
- Load the first IOS file in the flash
- Load the IOS file from TFTP server
- Load minimized IOS from ROM

Boot system command

- beside the configuration register you can use the boot system command to force booting location.

```
Router(config)# boot system flash
```

```
Router(config)# boot system rom
```

```
Router(config)# boot system tftp
```

Locating and Loading the IOS Image

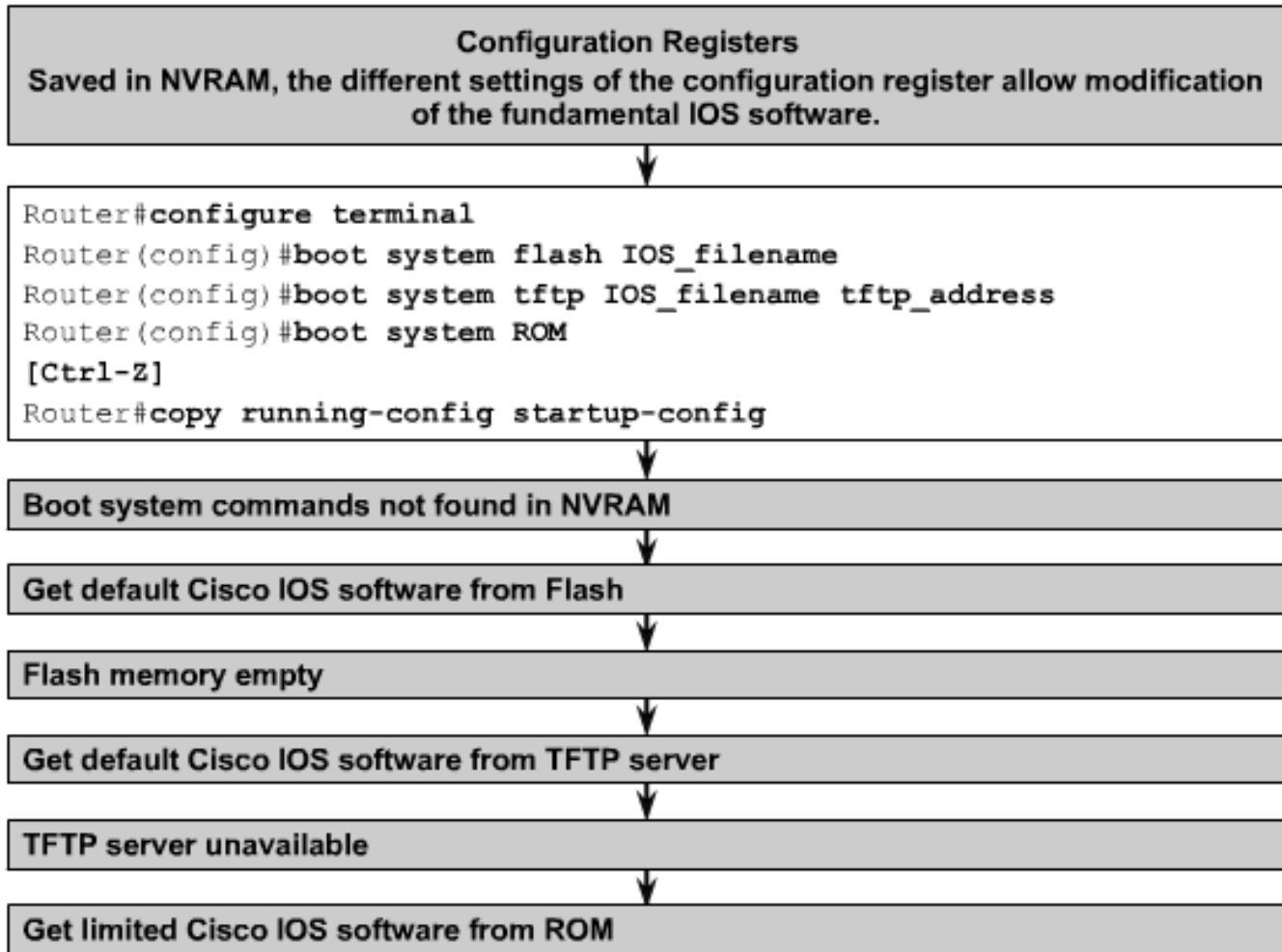

Editing Commands

<Ctrl><A>	Move to beginning of line
<Ctrl><E>	Move to the end of the line
<Esc>	Move back one word
<Ctrl><F>	Move forward one character
<Ctrl>	Move back on character
<Esc><F>	Move forward one word

\$ Sign means that the line has scrolled to the left

To disable enhanced editing mode, type `terminal no editing` at the privileged EXEC mode prompt.

Router Command History

Configure the Command History buffer

Cisco IOS CLI Command Syntax	
Enable terminal history. This command can be run from either user or privileged EXEC mode.	switch# terminal history
Configures the terminal history size. The terminal history can maintain 0 to 256 command lines.	switch# terminal history size 50
Resets the terminal history size to the default value of 10 command lines.	switch# terminal no history size
Disables terminal history.	switch# terminal no history

